

# Thule Rapid System Kit 1409

# > Instructions

**MITSUBISHI Outlander II**, 5-dr SUV, 06-12

**MITSUBISHI Outlander**, 5-dr SUV, \*07-

\*North America

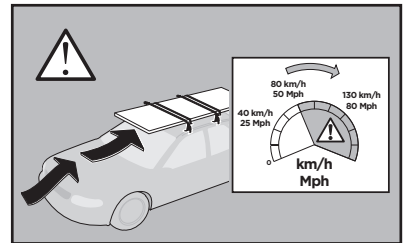
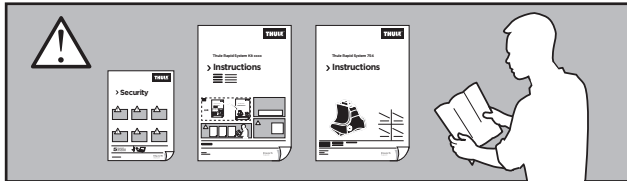
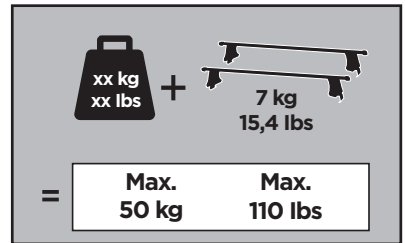
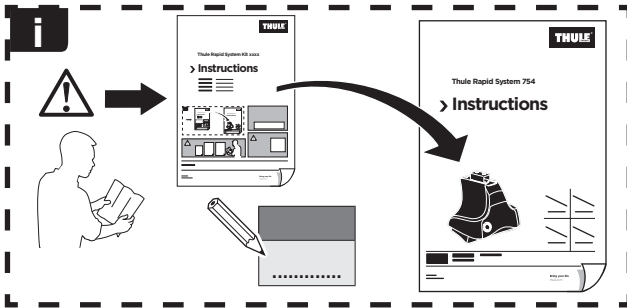

ISO 11154-E



239 x4

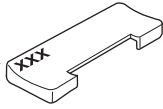

791 x2



792 x2



x1

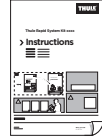

x1

# 1

	X (scale)	X (mm)	X (inch)
<b>MITSUBISHI Outlander II</b> , 5-dr SUV, 06-12	48	1131	44 1/2
<b>MITSUBISHI Outlander</b> , 5-dr SUV, *07-	48	1131	44 1/2

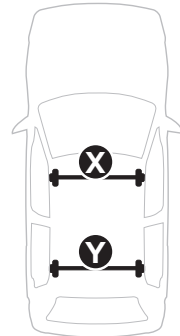
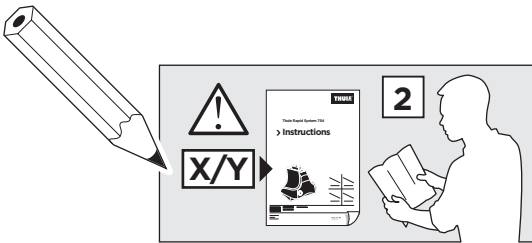

	Y (scale)	Y (mm)	Y (inch)
<b>MITSUBISHI Outlander II</b> , 5-dr SUV, 06-12	43,5	1086	42 3/4
<b>MITSUBISHI Outlander</b> , 5-dr SUV, *07-	43,5	1086	42 3/4

**2**

**MITSUBISHI Outlander II, 5-dr SUV, 06-12**

**MITSUBISHI Outlander, 5-dr SUV, \*07-**

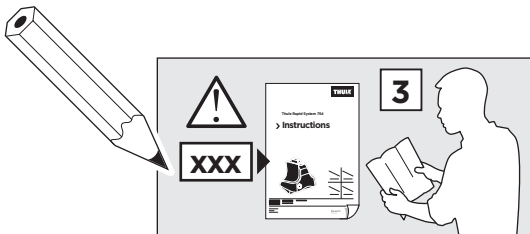
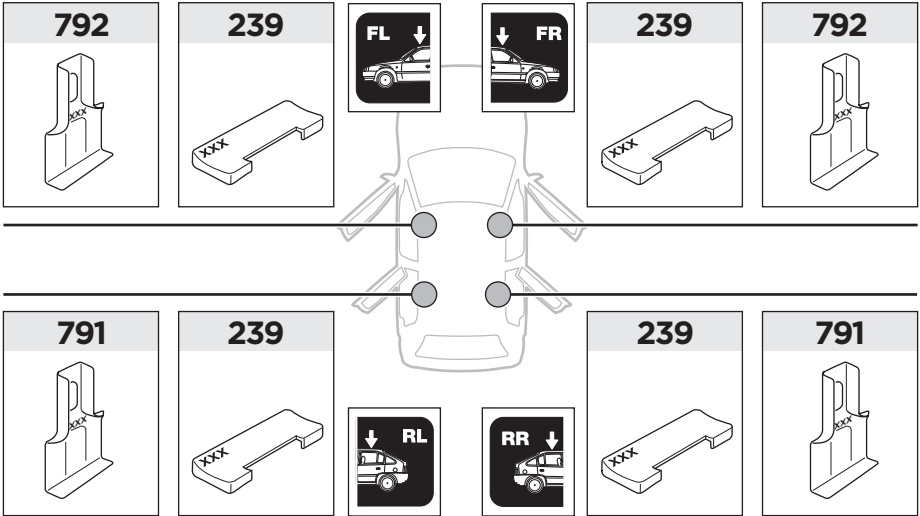

**3**

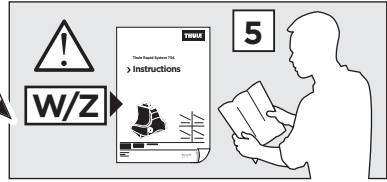
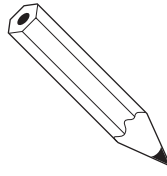

	W (mm)	Z (mm)	W (inch)	Z (inch)
<b>MITSUBISHI Outlander II</b> , 5-dr SUV, 06-12	<b>440</b>	<b>800</b>	<b>17 <sup>3</sup>/<sub>8</sub></b>	<b>31 <sup>1</sup>/<sub>2</sub></b>
<b>MITSUBISHI Outlander</b> , 5-dr SUV, *07-	<b>440</b>	<b>800</b>	<b>17 <sup>3</sup>/<sub>8</sub></b>	<b>31 <sup>1</sup>/<sub>2</sub></b>

