



Thule Rapid System Kit 1061

> Instructions

HONDA Concerto, 5-dr Hatchback, 89-98

ROVER 200, 3-dr Hatchback, 90-95

ROVER 200, 4-dr Sedan, 90-95

ROVER 200, 5-dr Hatchback, 90-95

ROVER 400, 4-dr Sedan, 90-95

ROVER 400, 5-dr Hatchback, 90-95

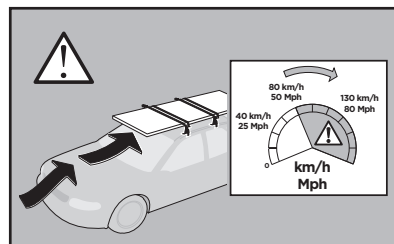
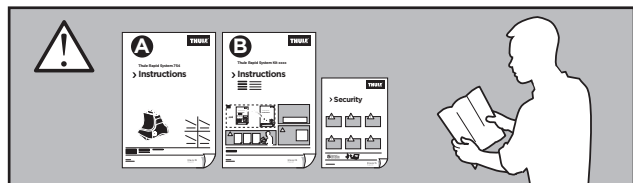
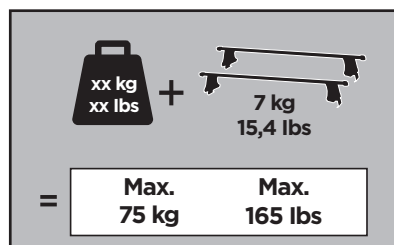
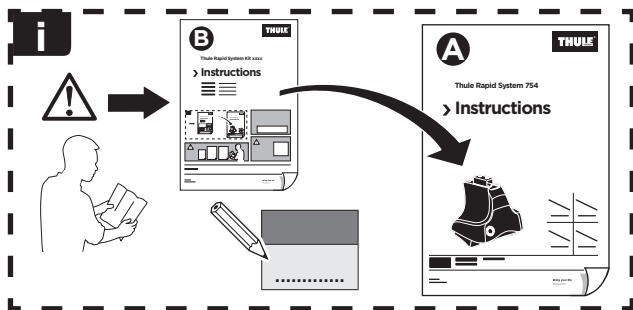

ISO 11154-E

141061

C.20130619
519-1061-01

Bring your life
thule.com

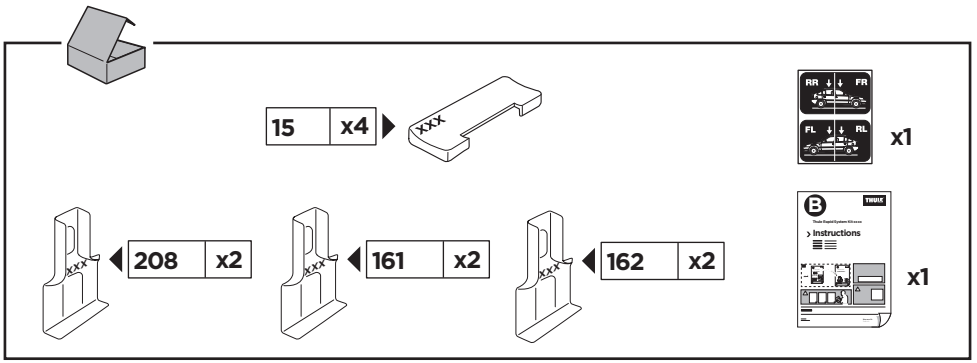

1

	X (scale)	X (mm)	X (inch)
HONDA Concerto , 5-dr Hatchback, 89-98	31,5	966	38
ROVER 200 , 3-dr Hatchback, 90-95	31,5	966	38
ROVER 200 , 4-dr Sedan, 90-95	31,5	966	38
ROVER 200 , 5-dr Hatchback, 90-95	31,5	966	38
ROVER 400 , 4-dr Sedan, 90-95	31,5	966	38
ROVER 400 , 5-dr Hatchback, 90-95	31,5	966	38

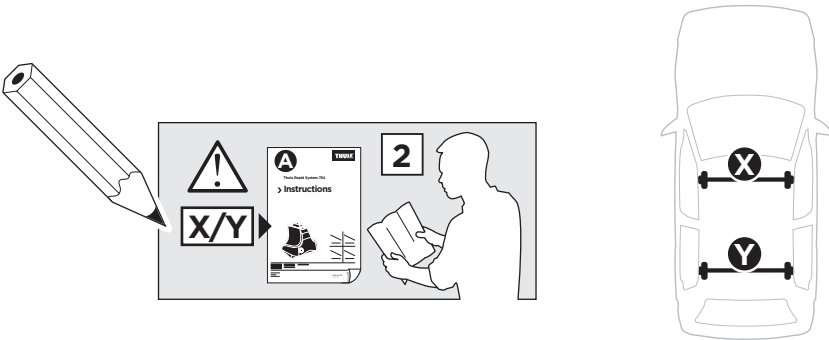

	Y (scale)	Y (mm)	Y (inch)
HONDA Concerto , 5-dr Hatchback, 89-98	28	931	36 ⁵ / ₈
ROVER 200 , 3-dr Hatchback, 90-95	28,5	936	36 ⁷ / ₈
ROVER 200 , 4-dr Sedan, 90-95	28	931	36 ⁵ / ₈
ROVER 200 , 5-dr Hatchback, 90-95	28	931	36 ⁵ / ₈
ROVER 400 , 4-dr Sedan, 90-95	28	931	36 ⁵ / ₈
ROVER 400 , 5-dr Hatchback, 90-95	28	931	36 ⁵ / ₈

2

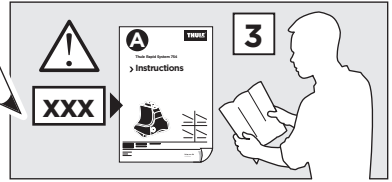
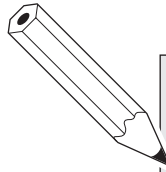

ROVER 200, 3-dr Hatchback, 90-95

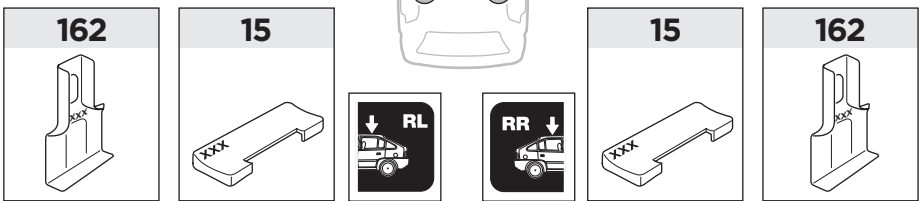
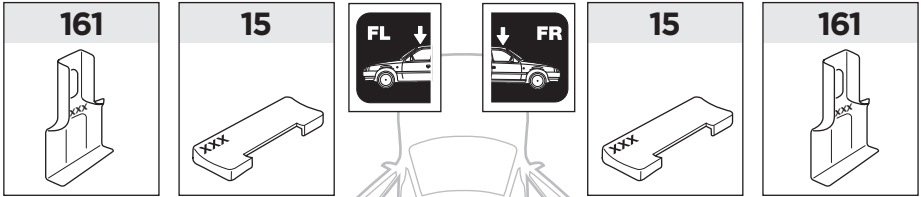

HONDA Concerto, 5-dr Hatchback, 89-98

ROVER 200, 4-dr Sedan, 90-95

ROVER 200, 5-dr Hatchback, 90-95

ROVER 400, 4-dr Sedan, 90-95

ROVER 400, 5-dr Hatchback, 90-95

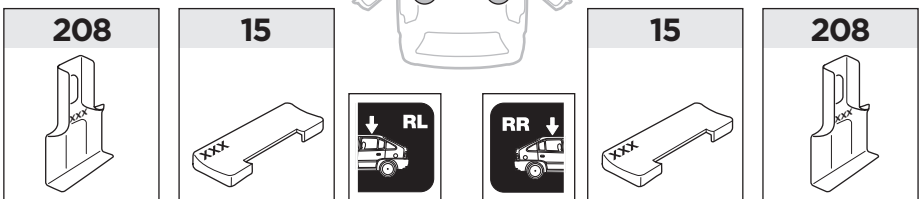
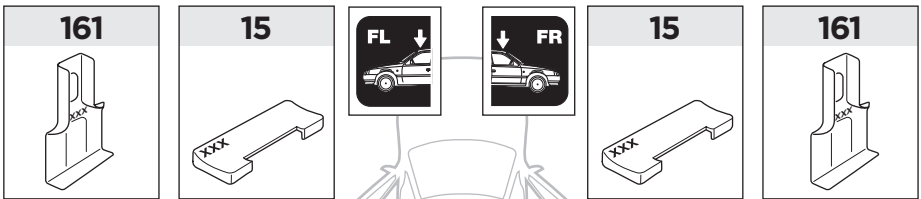

3

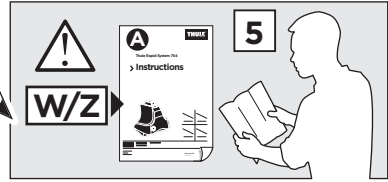
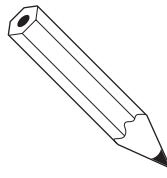

	W (mm)	Z (mm)	W (inch)	Z (inch)
HONDA Concerto , 5-dr Hatchback, 89-98	240	700	9 1/2	27 1/2
ROVER 200 , 3-dr Hatchback, 90-95	240	620	9 1/2	24 3/8
ROVER 200 , 4-dr Sedan, 90-95	200	700	7 7/8	27 1/2
ROVER 200 , 5-dr Hatchback, 90-95	200	700	7 7/8	27 1/2
ROVER 400 , 4-dr Sedan, 90-95	240	700	9 1/2	27 1/2
ROVER 400 , 5-dr Hatchback, 90-95	240	700	9 1/2	27 1/2

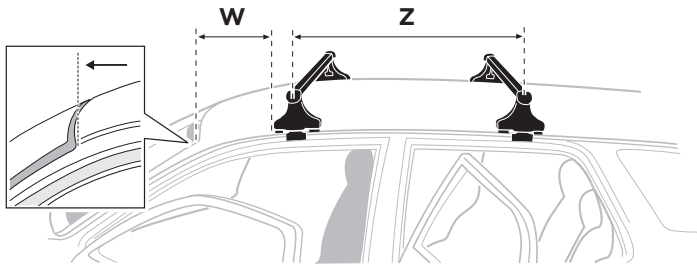

ROVER 200, 3-dr Hatchback, 90-95

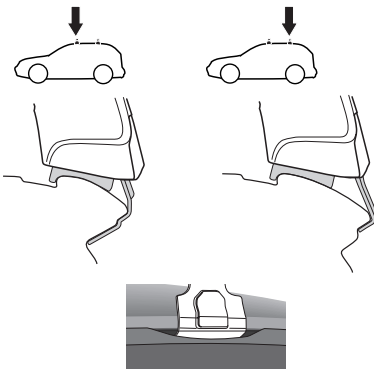

HONDA Concerto, 5-dr Hatchback, 89-98

ROVER 200, 4-dr Sedan, 90-95
ROVER 200, 5-dr Hatchback, 90-95
ROVER 400, 4-dr Sedan, 90-95
ROVER 400, 5-dr Hatchback, 90-95

