



# Thule Rapid System Kit 1710

## > Instructions

- VOLKSWAGEN e-Golf**, 5-dr Hatchback, 15-
- VOLKSWAGEN Golf VII**, 3-dr Hatchback, 13-17 / \*15-
- VOLKSWAGEN Golf VIII**, 3-dr Hatchback, 17-
- VOLKSWAGEN Golf VII**, 5-dr Hatchback, 13-17 / \*15-
- VOLKSWAGEN Golf VIII**, 5-dr Hatchback, 17-
- VOLKSWAGEN GTI VII**, 3-dr Hatchback, \*15-
- VOLKSWAGEN GTI VII**, 5-dr Hatchback, \*15-

\*North America

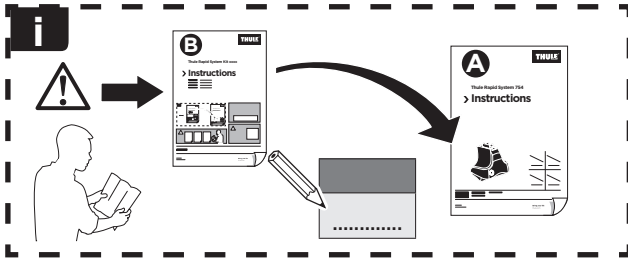

xx kg xx lbs	+		7 kg 15,4 lbs
			3 kg 6,6 lbs
=	3-dr	Max. 50 kg	Max. 110 lbs
=	5-dr	Max. 60 kg	Max. 132 lbs

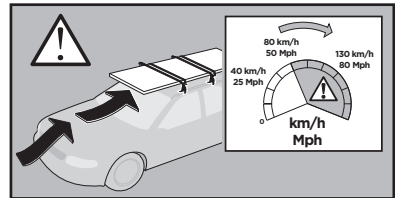
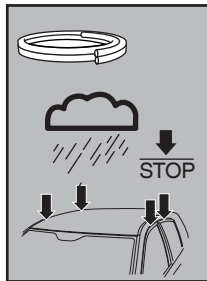
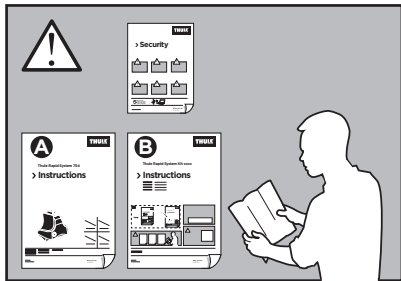

ISO 11154-E

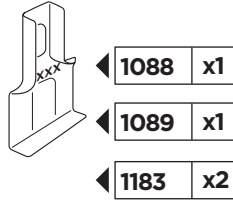
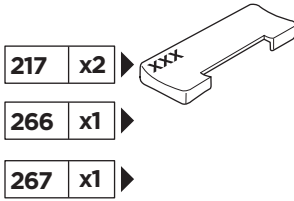
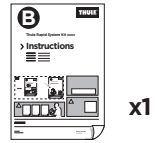

# 1

	X (scale)	X (mm)	X (inch)
<b>VOLKSWAGEN e-Golf</b> , 5-dr Hatchback, 15-	<b>39</b>	<b>1041</b>	<b>41</b>
<b>VOLKSWAGEN Golf VII</b> , 3-dr Hatchback, 13-17 / *15-	<b>39</b>	<b>1041</b>	<b>41</b>
<b>VOLKSWAGEN Golf VIII</b> , 3-dr Hatchback, 17-	<b>39</b>	<b>1041</b>	<b>41</b>
<b>VOLKSWAGEN Golf VII</b> , 5-dr Hatchback, 13-17 / *15-	<b>39</b>	<b>1041</b>	<b>41</b>
<b>VOLKSWAGEN Golf VIII</b> , 3-dr Hatchback, 17-	<b>39</b>	<b>1041</b>	<b>41</b>
<b>VOLKSWAGEN GTI VII</b> , 3-dr Hatchback, *15-	<b>39</b>	<b>1041</b>	<b>41</b>
<b>VOLKSWAGEN GTI VII</b> , 5-dr Hatchback, *15-	<b>39</b>	<b>1041</b>	<b>41</b>

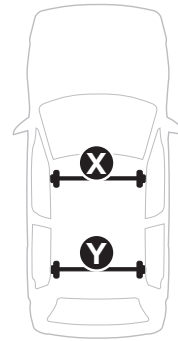
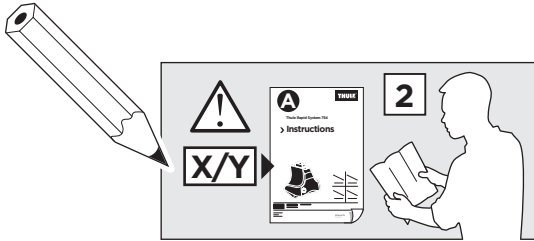

	Y (scale)	Y (mm)	Y (inch)
<b>VOLKSWAGEN e-Golf</b> , 5-dr Hatchback, 15-	<b>31</b>	<b>961</b>	<b>37 <sup>7</sup>/<sub>8</sub></b>
<b>VOLKSWAGEN Golf VII</b> , 3-dr Hatchback, 13-17 / *15-	<b>31</b>	<b>961</b>	<b>37 <sup>7</sup>/<sub>8</sub></b>
<b>VOLKSWAGEN Golf VIII</b> , 3-dr Hatchback, 17-	<b>31</b>	<b>961</b>	<b>37 <sup>7</sup>/<sub>8</sub></b>
<b>VOLKSWAGEN Golf VII</b> , 5-dr Hatchback, 13-17 / *15-	<b>31</b>	<b>961</b>	<b>37 <sup>7</sup>/<sub>8</sub></b>
<b>VOLKSWAGEN Golf VIII</b> , 5-dr Hatchback, 17-	<b>31</b>	<b>961</b>	<b>37 <sup>7</sup>/<sub>8</sub></b>
<b>VOLKSWAGEN GTI VII</b> , 3-dr Hatchback, *15-	<b>31</b>	<b>961</b>	<b>37 <sup>7</sup>/<sub>8</sub></b>
<b>VOLKSWAGEN GTI VII</b> , 5-dr Hatchback, *15-	<b>31</b>	<b>961</b>	<b>37 <sup>7</sup>/<sub>8</sub></b>

2

**VOLKSWAGEN Golf VII**, 3-dr Hatchback, 13-17 / \*15-  
**VOLKSWAGEN Golf VIII**, 3-dr Hatchback, 17-  
**VOLKSWAGEN GTI VII**, 3-dr Hatchback, \*15-

SRA

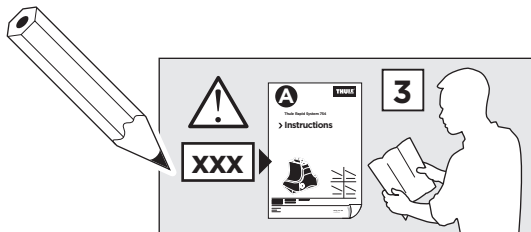
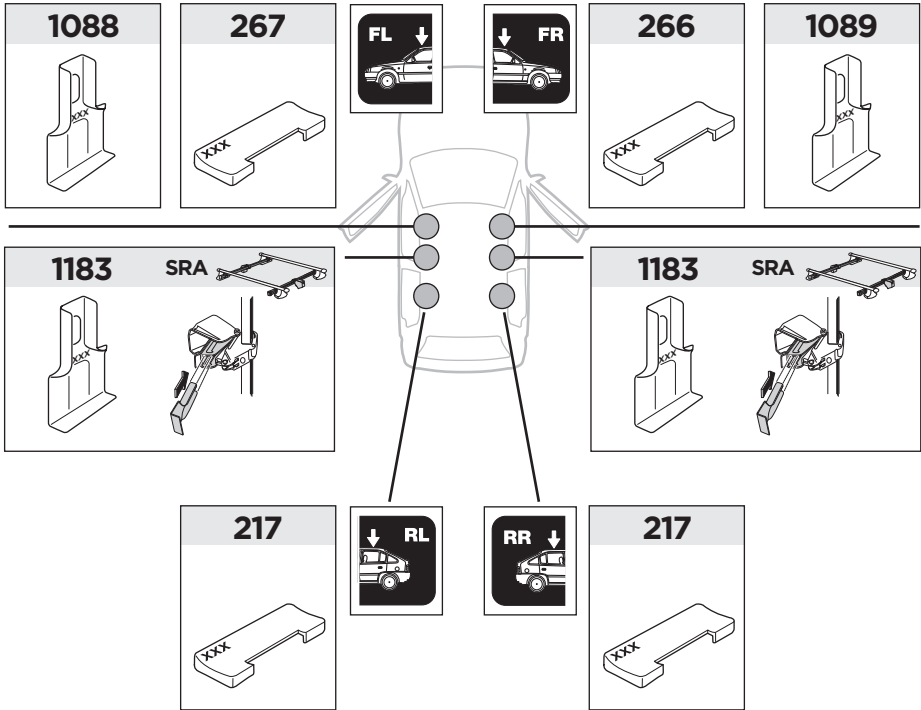
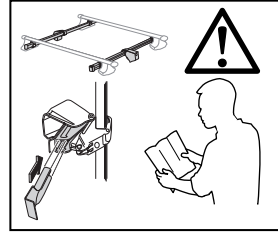

2

**VOLKSWAGEN e-Golf**, 5-dr Hatchback, 15-  
**VOLKSWAGEN Golf VII**, 5-dr Hatchback, 13-17 / \*15-  
**VOLKSWAGEN Golf VIII**, 5-dr Hatchback, 17-  
**VOLKSWAGEN GTI VII**, 5-dr Hatchback, \*15-

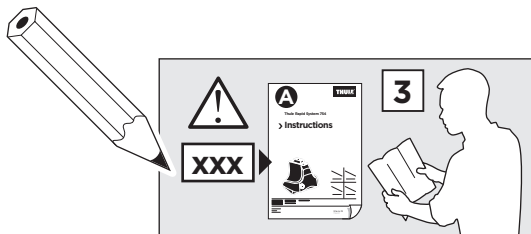
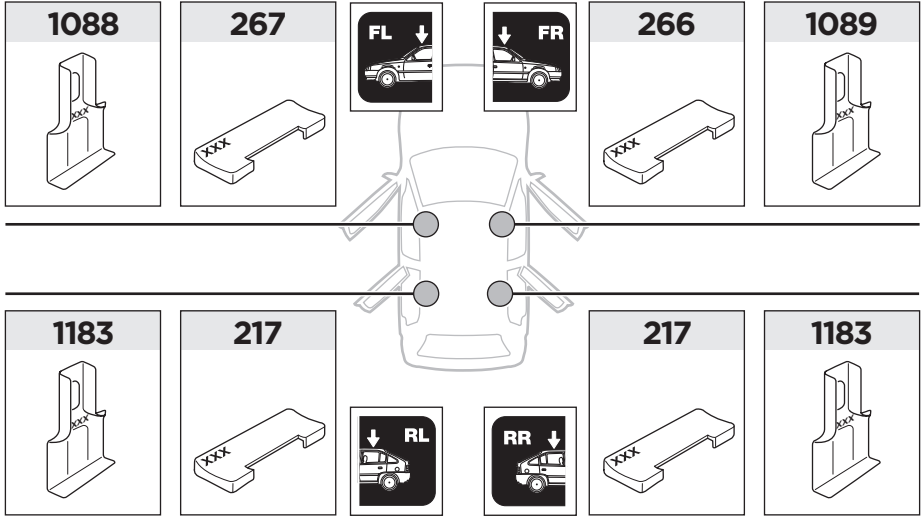

3

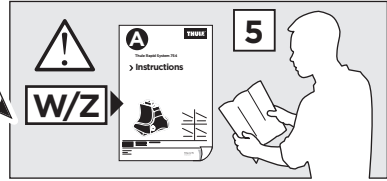
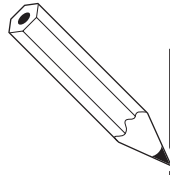

	W (mm)	Z (mm)	Y (mm)	W (inch)	Z (inch)	Y (inch)
<b>VW Golf VII</b> , 3-dr Hatchback, 13-17 / *15-	230	710	460	9	28	18 <sup>1</sup> / <sub>8</sub>
<b>VW Golf VIII</b> , 3-dr Hatchback, 17-	230	710	460	9	28	18 <sup>1</sup> / <sub>8</sub>
<b>VW GTI VII</b> , 3-dr Hatchback, *15-	230	710	460	9	28	18 <sup>1</sup> / <sub>8</sub>

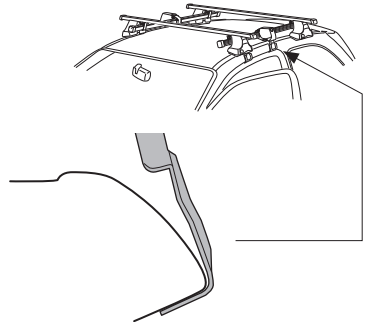
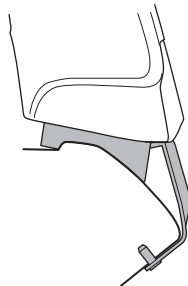
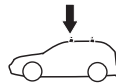
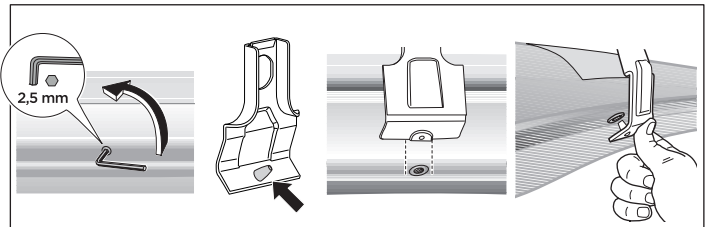
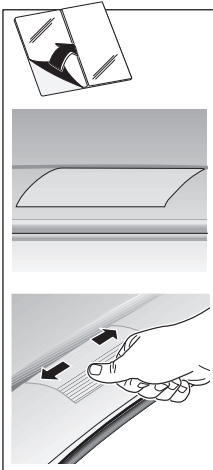
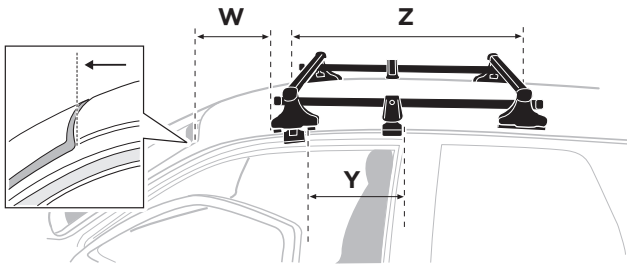

3

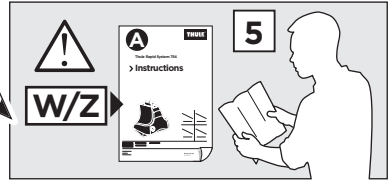
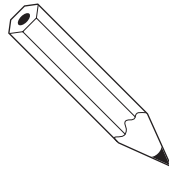

	W (mm)	Z (mm)	W (inch)	Z (inch)
<b>VOLKSWAGEN e-Golf</b> , 5-dr Hatchback, 15-	<b>230</b>	<b>710</b>	<b>9</b>	<b>28</b>
<b>VOLKSWAGEN Golf VII</b> , 5-dr Hatchback, 13-17 / *15-	<b>230</b>	<b>710</b>	<b>9</b>	<b>28</b>
<b>VOLKSWAGEN Golf VIII</b> , 5-dr Hatchback, 17-	<b>230</b>	<b>710</b>	<b>9</b>	<b>28</b>
<b>VOLKSWAGEN GTI VII</b> , 5-dr Hatchback, *15-	<b>230</b>	<b>710</b>	<b>9</b>	<b>28</b>

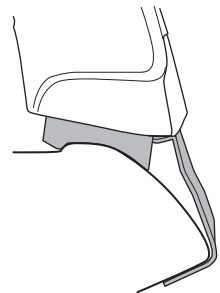
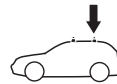
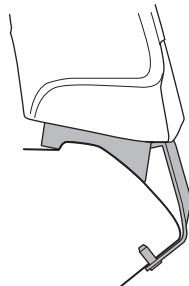
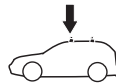
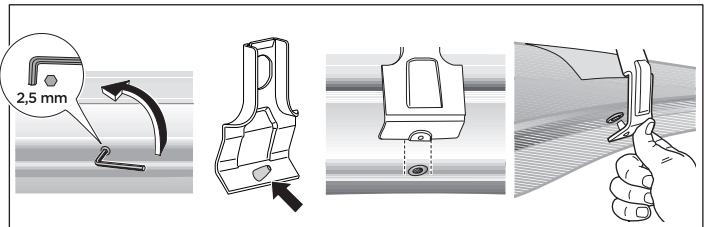
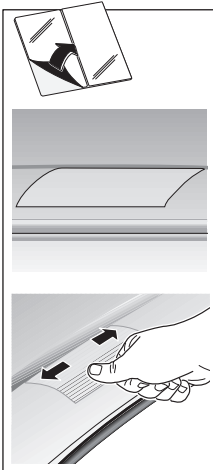
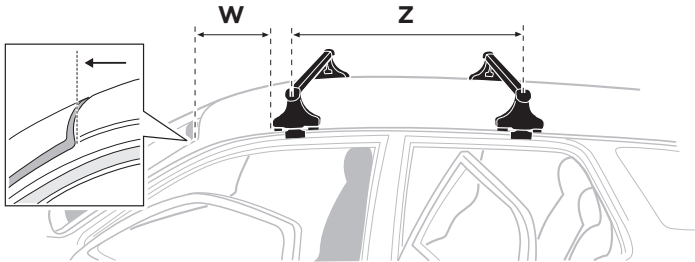

4

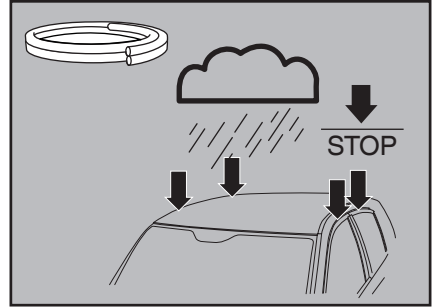
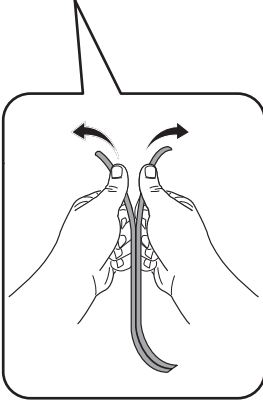

3-dr

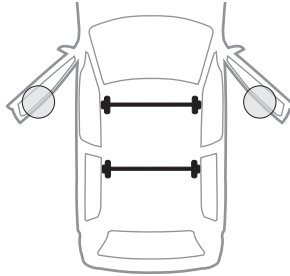

5-dr

